

NETWORK SYSTEM FOR ASSESSING THE MOISTURE AND THERMAL BEHAVIOUR OF REPAIRED CONCRETE BUILDING FACADES

PUBLISHED: March 2011

EDITOR: Turk Ž.

Fahim Al-Neshawy, Lic.Sc. (Tech.),

Jukka Piironen, M.Sc. (Tech.),

Susanna Peltola, M.Sc. (Tech.),

Esko Sistonen, Acting Professor

Jari Puttonen, Professor

*Department of Civil and Structural Engineering, School of Engineering, Aalto University, Finland;
fahim.al-neshawy@aalto.fi or firstname.lastname@aalto.fi*

SUMMARY: *Moisture is one of the major factors in the physical deterioration processes of building facades. Physical deteriorations are typically caused by restrained moisture movements and freezing or are connected to chemical or biological attacks. Changes in moisture and temperature lead to the swelling and shrinking of building materials. Freezing of water in pores and cracks leads to an increase in volumes and causes scaling and spalling of materials. The continuous monitoring of temperature and relative humidity provides significant information about the long-term performance of buildings. Documenting the performance of repaired facades through this monitoring can enhance our understanding of the long term deterioration of materials and the changes in the structural behaviour due to aging.*

One objective of the research was to test the new possibilities offered by ICT (Information and Communication Technology) in the real estate and construction sector. For that purpose, a new relative humidity and thermal monitoring network system (RHT-MNS) was developed. The (RHT-MNS) is useful for assessing the performance of repaired building facades. It also gives information about the physical functioning of facades.

A field study for testing the RHT-MNS was carried out to monitor the temperature and relative humidity of a facade that was repaired by adding external mineral wool insulation and a rendering system (Sto AG, Sto Therm Vario, Finexter Oy) consisting of 6 mm of rendering coat and glass fibre mesh. The monitoring was carried out at regular intervals of 15 minutes since the year 2004.

The results of relative humidity and temperature monitoring provide an opportunity to have a close look at the hygrothermal performance of the building facade. The results show that the original facade structure is drying after adding the external wall insulation and rendering system.

The RHT-MNS monitoring network system has proven to be a new successful method for monitoring the thermal and moisture conditions in repaired building facades. The RHT-MNS monitoring network system is also reliable, inexpensive, fast to assemble and easy use.

KEYWORDS: *ICT, monitoring, thermal, moisture, repaired facades, concrete.*

REFERENCE: Fahim Al-Neshawy, Jukka Piironen, Susanna Peltola, Esko Sistonen, Jari Puttonen (2011) *Network system for assessing the moisture and thermal behaviour of repaired concrete building facades*, *Journal of Information Technology in Construction (ITcon)*, Vol. 16, pg. 601-616, <http://www.itcon.org/2011/34>

COPYRIGHT: © 2011 The authors. This is an open access article distributed under the terms of the Creative Commons Attribution 3.0 unported (<http://creativecommons.org/licenses/by/3.0/>), which permits unrestricted use, distribution, and reproduction in any medium, provided the original work is properly cited.



1. INTRODUCTION

Deterioration of building facades may arise internally due to the properties of materials or externally due to the surrounding environment. The deterioration of building facades represents a huge cost in terms of unscheduled maintenance and repair as well as a potential public safety concern. This deterioration is expected to become increasingly important with time. According to the Department of Statistics Finland, the value of house building renovation was about 4.3 billion Euros in 2009, which was 35 per cent of the total value of house building construction.

Deterioration of concrete is one of the basic questions in the life time management of buildings and structures. Two of the most important factors in building deterioration subjected to outdoor conditions are moisture and temperature. Moisture is a major factor in the physical deterioration processes that are typically caused by restrained moisture movements and freezing or it can be connected to chemical or biological attacks. In addition, moisture will increase the heat flow through a structure and thus increase the consumption of heating energy. (Huovinen et al. 1998).

Karagiozis (2002) has focused on controlling the accumulation of moisture in building envelopes. The focus on improving the thermal performance of building envelope has affected other aspects of building enclosure performance, most notably moisture performance. Building envelope tightness and insulation levels have increased over time, as have the number of problems due to moisture accumulation. Moisture accumulation seriously restricts not only the life span of building envelopes, but also impacts indoor air quality and thermal performance.

According to Norris (2008), the current destructive testing systems and methods for the internal moisture evaluation are expensive and time consuming. In addition, these techniques require intensive labour and special equipment to gain access to remote locations. Handheld moisture meters are usually used in spot checks to assess changes in the moisture content of the building components or to determine surface wetting patterns in order to determine sources and extent of wetness. Data acquisition systems are usually used for long-term monitoring: a data acquisition system consists of temperature and humidity sensors and data loggers for collecting data for further processing and archiving (Lindblom-Patkus 2007).

An objective of this research was to test the new possibilities offered by Information and Communication Technology (ICT) to be used in the building repairing and maintenance. The purpose of the research was to develop a methodology to assess the effect of the ambient environment on the components of concrete building facades. (Al-Neshawy, 2007). This paper focuses on the development of a relative humidity and temperature monitoring network system for repaired concrete building facades. The paper also illustrates outputs from this innovative monitoring system.

2. RELATIVE HUMIDITY AND TEMPERATURE MONITORING NETWORKS

The basic components of the relative humidity and temperature monitoring networks are moisture and temperature sensors, a data acquisition device and the software application for data processing. Both data and operating power required by the sensors are transmitted among the monitoring network wirelessly or via power and data cables (Räisänen, 2005). Two examples of the relative humidity and temperature monitoring networks are shown in Fig. 1.

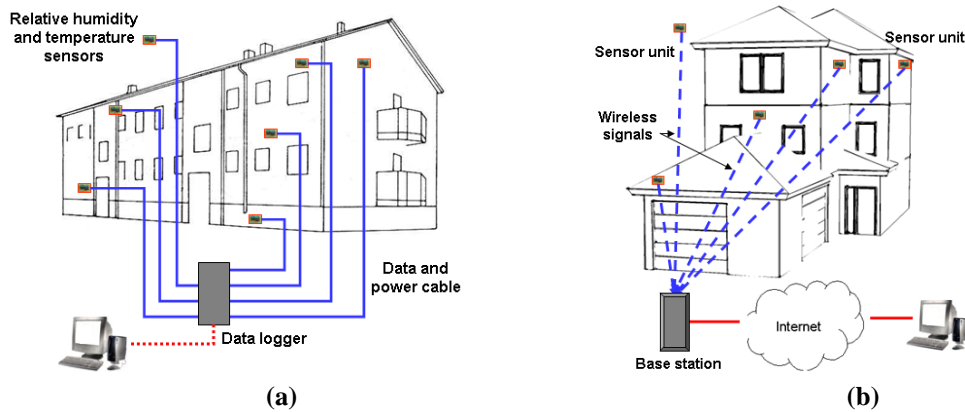

FIG. 1: Schematic diagram of the relative humidity and temperature monitoring networks: a) data logging network, b) wireless sensing network

The data logging network in Fig. 1(a) consists of relative humidity and temperature sensors connected via cable to the data logger. The data loggers are battery or electricity powered instruments that record the required data at intervals determined by the user. Typically, the data is then transferred between the data logger and a personal computer by a cable. Once the data has been downloaded, software provided with the data logger allows the user to produce customized charts and graphs that illustrate conditions over time (Lindblom-Patkus, 2007).

The wireless sensing system in Fig. 1(b) consists of sensor units and a base station. The sensors transmit the measured data over a secure wireless link to the base station. Measurement and transmission intervals can be set by means of software on a personal computer.

Napaka! Vira sklicevanja ni bilo mogoče najti. shows some widely used relative humidity and temperature measurement devices. The accuracy of the capacitive relative humidity sensors is typically $\pm 2\text{--}3\%$, which in case of normal concrete, corresponds to deviation about $\pm 0.2\text{--}0.3\%$ in moisture quotient. With regular calibration, the accuracy may be even better (Voutilainen, 2005).



FIG. 2: Examples of relative humidity and temperature measurement devices (Voutilainen, 2005).

3. RHT-MNS MONITORING NETWORK SYSTEM

Since one goal of this study was to develop a relative humidity and thermal monitoring method to understand the moisture and thermal performance of repaired building facades, the proposed RHT-MNS network and RHT-MNS monitoring software were developed to gather and analyze large amounts of thermal and moisture data.

The RHT-MNS network was built on Linet Light Network (Linet Oy Ltd. 2007). The RHT-MNS network consists of a controller (LIC04), shown in Fig. 3, and nodes to which the relative humidity and the temperature sensors are connected. The controller provides configuration services and enables communication with the data acquisition system. The network system may contain up to 200 nodes connected to a twisted-pair CAT5 cable with a maximum total length of 1000 meters. A schematic diagram of the RHT-MNS monitoring network system is illustrated in Fig. 3.

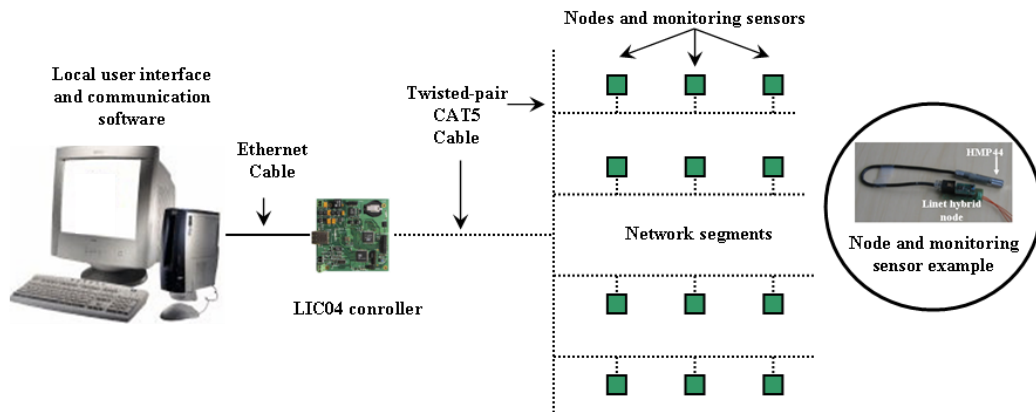

FIG. 3: Schematic diagram of the (RHT-MNS) relative humidity and thermal monitoring network system

A special software application was developed for connecting the network system to the host computer for collecting relative humidity and temperature data, and for analysing the collected data. The software was developed using Microsoft Visual Basic 6.0. The RHT-MNS software runs on Microsoft Windows platforms. The RHT-MNS monitoring software is used to configure the RHT-MNS system, connect with the network controller, calculate the relative humidity and temperature data and process these data into charts.

3.1 Design of the RHT-MNS monitoring network system

In the development process of the RHT-MNS network system is outlined in Fig. 4. The goals are to develop a new method for measuring the relative humidity and temperature of the concrete structures. The new method had to be non-destructive, yet able to measure the thermal and moisture conditions at exact and predefined locations inside the structures. The system had to be inexpensive, easy and fast to assemble and use.

The development process of the RHT-MNS network system included the assembly of the network components, development and implement of the software, test the system at the laboratory and then installing the system at the field.

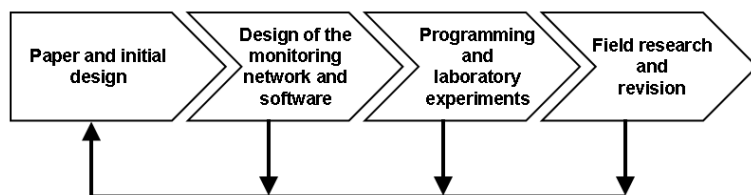

FIG. 4: The design cycle of the RHT-MNS monitoring network system

3.2 The RHT-MNS network components

RHT-MNS network controller

The LIC04 network controller, shown in Fig. 5, is a stand-alone network power supply and controller for the network system. The LIC04 controller accepts IP/UDP (Internet Protocol/User Datagram Protocol) connections and only transmits data on demand. The controller receives and sends packets in binary format. Data entities are 8 or 16 bits unsigned integers. The same data structure is used to send and receive data to and from the controller.

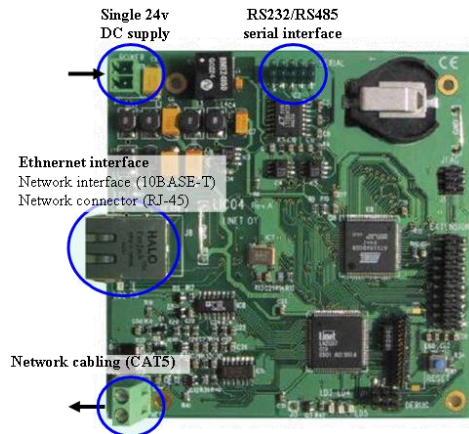

FIG. 5: LIC04 network controller card

RHT-MNS network nodes

A RHT-MNS network node, shown in Fig. 6, is a network adapter that incorporates fixed I/O (Input/Output) functions for general control network applications. The nodes used in the RHT-MNS monitoring network system are hybrid nodes configured as 12-bit data and AD/state (Analog-Digital) groups.

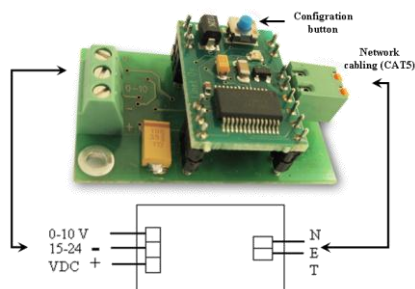

FIG. 6: The RHT-MNS monitoring network system hybrid node



RHT-MNS monitoring network cabling

The type of cable used at RHT-MNS monitoring network system is a standard type CAT5. Inside the jacket of any grade of unshielded twisted pair cable (UTP) are four individual pairs of wires, with the wires of each individual pair twisted around each other in a spiral fashion that helps minimize and cancel out some of the problems that can disrupt data over the wire. When connecting the controller of the RHT-MNS monitoring network system to the internet an Ethernet CAT5 cable with a RJ-45 (Standard Ethernet) connector is used. An Ethernet crossover cable is used for connecting the controller directly to the host computer.

RHT-MNS network sensors

The relative humidity and temperature sensors were chosen to provide the required functionality for correct system operation. There are a number of sensors available for this type of application. For the RHT-MNS monitoring network system, three different types of sensors were selected to be connected to the nodes: PT100 sensors for temperature measurements and HMP44 and SHT15 sensors for relative humidity measurements. The choice of HMP44 and PT100 sensors was based on stability, accuracy and the long experience in using these sensors. SHT15 was selected based on its low price and compatibility with the network nodes. The calibration of the relative humidity sensors were confirmed by the manufacturers. Details of the sensors used in the RHT-MNS monitoring network system are shown in Table 1.

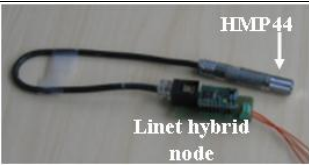
TABLE 1: Relative humidity and temperature sensors used in the RHT-MNS monitoring network system

Sensor	Manufacturer	Output data	Linnet data group type	Sensor connected to Linnet hybrid node
HMP 44	Vaisala Oy, Finland	RH (%)	AD / state	
SHT15	Sensirion AG Switzerland	RH (%) and T (°C)	12 bit data	
PT100	Labfacility temperature and process technology, UK	T (°C)	AD / state	

3.3 RHT-MNS monitoring software

The RHT-MNS software communicates between the host computer and the RHT-MNS network controller, and it collects and processes the monitored data. The software was developed using Microsoft Visual Basic 6.0. The RHT-MNS monitoring software runs on Microsoft Windows platforms. The RHT-MNS software consists of four basic modules: a system configuration module, a Telnet simulation module, a relative humidity and temperature output module and a data processing module. The flow chart of the RHT-MNS software modules is shown in Fig. 7.

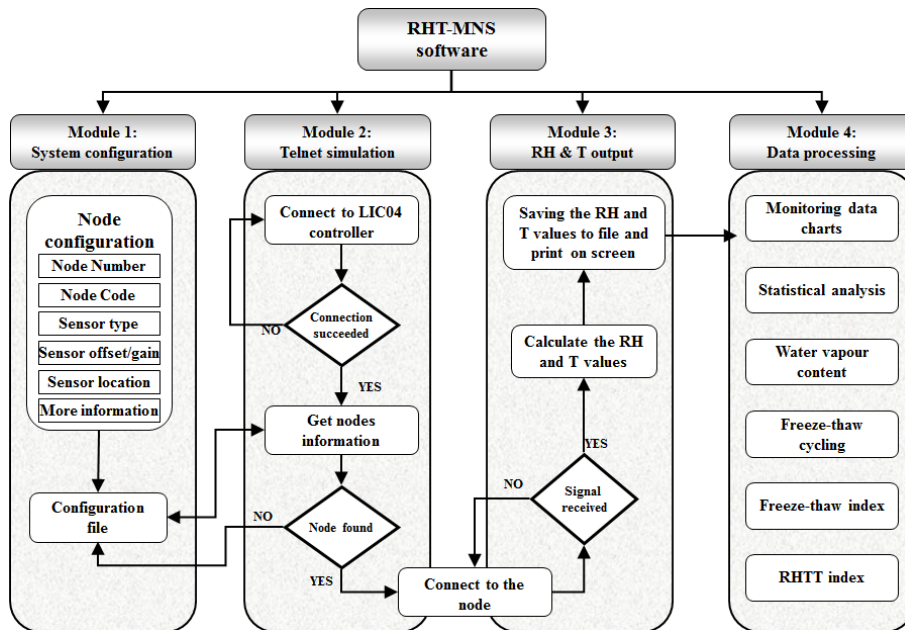

FIG. 7: Flow chart of the RHT-MNS monitoring software

Module 1: System configuration

The system configuration module consists of two parts: the configuration of the cross-section of monitored structure and the configuration of the sensors and nodes. The configuration of the cross-section includes information about the cross-section code and the number of the first and last nodes in the cross-section. The information of the cross-section is stored in a configuration file “cross-sections.cfg”, which is used by the data processing module.

The node and sensor configuration includes information such as the node number, code, the sensor type, the location of the sensor connected to the node, and the monitored cross-section code. The information of node and sensor configuration is stored in a configuration file “sensors.cfg”, which is used by the RHT-MNS calculation and output module.

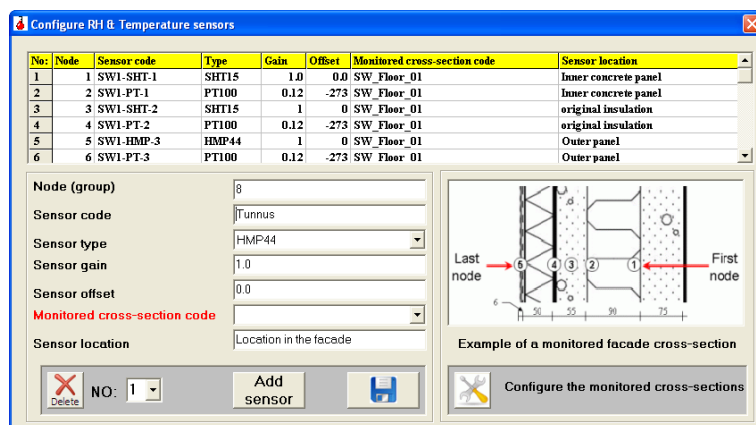

FIG. 8: Configuration of the sensors and nodes of RHT-MNS network

Module 2: Telnet simulation

The Telnet simulation module is used in communication with the LIC04 controller. The user inputs information about the controller IP address (Internet Protocol address) and the communication port between the LIC04 controller and the host computer. The Telnet terminal then sends and receives data continuously from the LIC04

controller. In the RHT-MNS monitoring software, the commands are sent to query the controller at certain intervals, and the corresponding data is received. Information about the nodes of the RHT-MNS monitoring network system is shown in the graphical user interface of the Telnet simulation module as shown in Fig. 9.

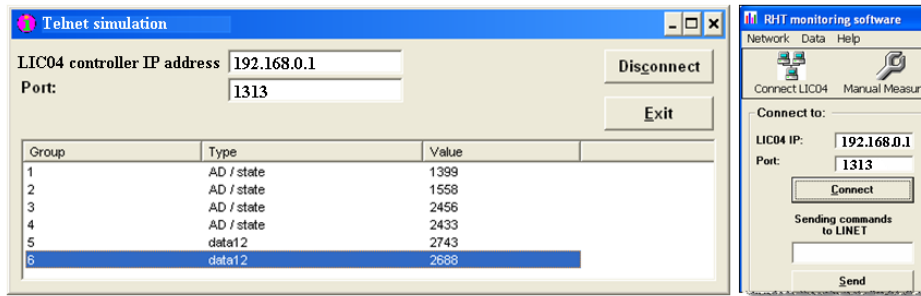

FIG. 9: The graphical user interface of the Telnet simulation module

Module 3: Relative humidity and temperature output

The relative humidity and temperature output module, shown in Fig. 10, is used for calculating the temperature and relative humidity values taking into consideration the offset and gain of every sensor then saving the resulting values in an ASCII file and displaying the values on the screen.

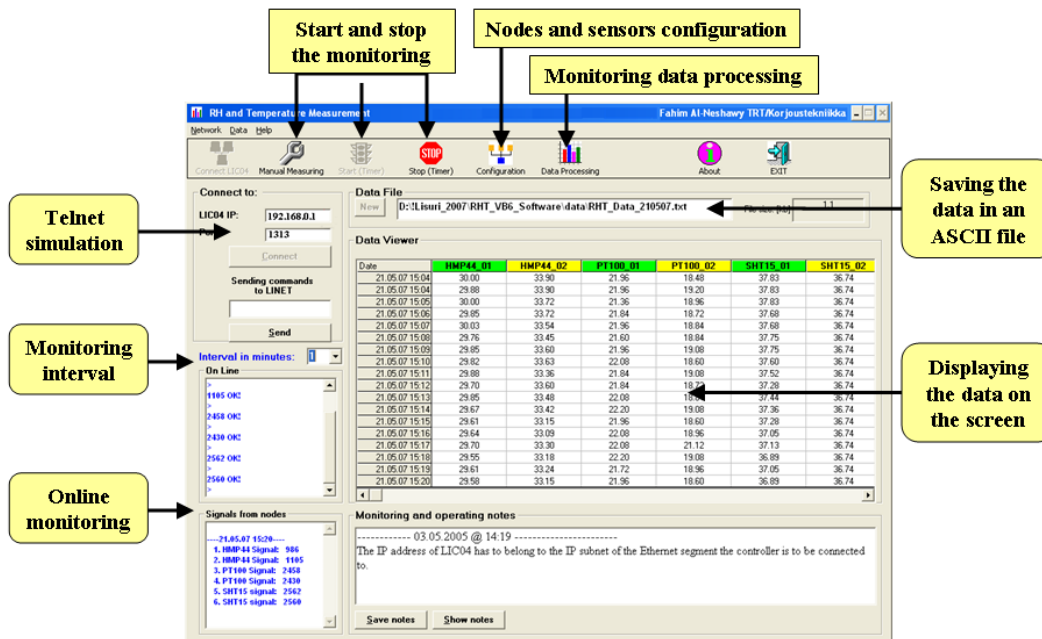

FIG. 10: The graphical user interface of the Relative humidity and temperature output module

According to the data sheet of the sensor SHT15 (Sensirion AG, 2007), the non-linearity of the humidity sensor is compensated by using the following quadratic polynomial formula to convert the output signal of the sensor SHT15 to a relative humidity value.

$$RH_{Linear} = c_1 + 2 \times c_2 \times (SHT15_{RH} - 2048) + c_3 \times (SHT15_{RH} - 2048)^2$$

where:

- RH_{Linear} is the calculated relative humidity value, %
- $SHT15_{RH}$ is the SHT15 output signal for relative humidity

c_1 , c_2 and c_3 are conversion coefficients for the relative humidity, as shown in table 2

TABLE 2. The conversion coefficients for relative humidity.

SHT15RH	c_1	c_2	c_3
12 bit	-4	0.0405	$-2.8 * 10^{-6}$
8 bit	-4	0.648	$-7.2 * 10^{-4}$

The relative humidity value using the HMP44 sensor is calculated from the following equation:

$$RH = (0.03 \times HMP44_{signal}) \times gain + offset$$

where:

- RH is the calculated relative humidity value, %
- $HMP44_{signal}$ is the HMP44 output signal for relative humidity
- gain is the gain value for the HMP44 sensor
- offset is the offset value for the HMP44 sensor

The values of the gain and offset for the HMP44 sensor are unique and supplied by the manufacturer for each of the sensors.

The temperature value for the PT100 sensor is calculated from the following equation:

$$T = (PT100_{signal}) \times gain + offset$$

where:

- T is the calculated temperature value, °C
- $PT100_{signal}$ is the PT100 output signal for temperature
- gain is the gain value for the PT100 sensor
- offset is the offset value for the PT100 sensor

The values of the gain and the offset were calculated by calibrating the PT100 sensors at temperatures of +20°C, and +50°C.

Data processing module

The data processing module processes the monitored temperature and relative humidity data. The data processing module was developed using Visual Basic for Applications under Microsoft Excel.

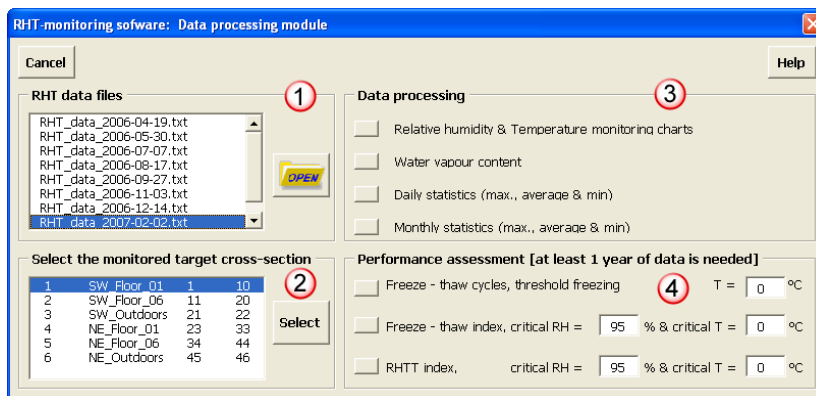

FIG. 11: The graphical user interface of the data processing module

As shown in Fig. 11, the monitored relative humidity and temperature data is processed in four steps presented as follows:

1. Selecting and opening the data file
2. Selecting the monitored target cross section of the structure and the first and last node in the section. The module will create a new data sheet for the cross-section and then copy the corresponding data into it.
3. Analysing the relative humidity and temperature data for the selected cross-section:
 - plotting the relative humidity and temperature data into graphical charts
 - calculating the water vapour content on the selected cross-section
 - calculating daily or monthly minimum, average and maximum temperature and relative humidity across the selected cross-section
4. Analysing the thermal and moisture performance of the selected cross-section for more than one year monitoring period by calculating:
 - the number of freezing and thawing cycles for different threshold freezing temperatures
 - the freezing and thawing index for the critical relative humidity and temperature entered by the module user
 - the RHTT index for different values of critical relative humidity and temperature entered by the module user. The RHTT index is calculated from the relative humidity and temperature values over a period of time.

The results from the temperature and relative humidity data processing application are saved as Microsoft Excel workbook for later reviewing, processing, and analysis.

4. RESULTS OF THE MONITORING OF THE MOISTURE AND TEMPERATURE

For testing the developed RHT-MNS monitoring network system, field research was carried out to monitor the relative humidity and temperature of a repaired concrete facade. The building, shown in Fig. 12, is a four-storey apartment building built with concrete sandwich elements. The concrete facade was repaired by adding 70 mm external mineral wool insulation and rendering system (Sto AG, Sto Therm Vario, Finexter Oy) which consists of a 6 mm of rendering coat and a glass fibre mesh.

The monitoring system was installed in the facades facing northeast and southwest, as illustrated in Fig. 12. The nodes and sensors were installed on the first and on the third floor of the building, as shown in Fig 12(a). The sensors were installed through the cross-sections of the facades as shown in Fig. 12(b). The thermal and moisture condition was monitored at a regular interval of 15 minutes.

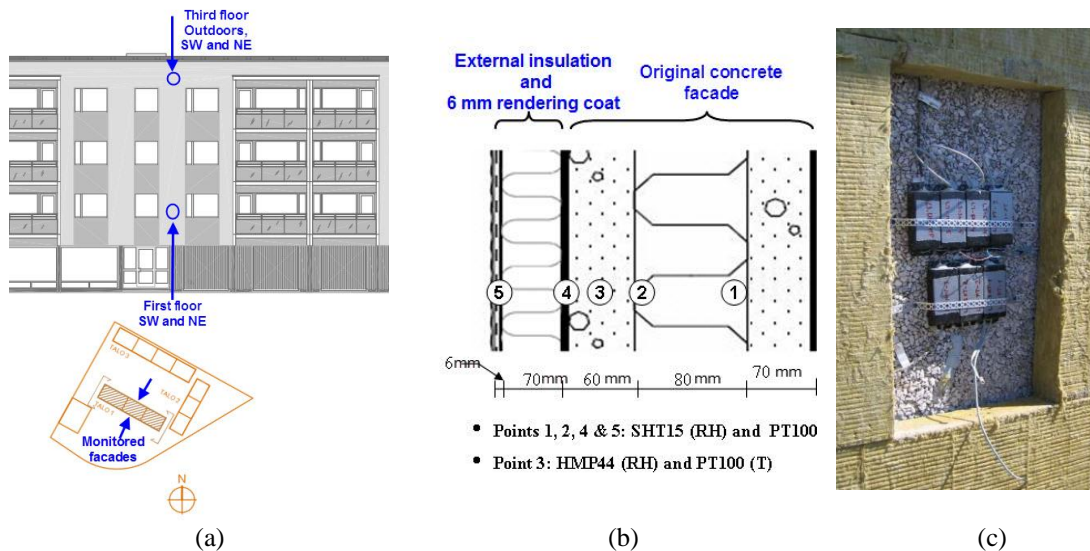

FIG. 12: The repaired facade of the monitored building and the location of the installed temperature and relative humidity sensors.

The temperature and relative humidity monitoring data process records the structure's response to the outdoors conditions and can correlate the potential for deterioration due to the change in temperature and relative humidity. Examples of the results for the temperature and relative humidity monitoring are presented from the year 2005 to the beginning of the year 2010 in Figs. 13-15.

4.1 The time of wetness and time of freezing

The time of wetness, or TOW, is defined as the fraction of the year when the relative humidity is above 80% and the temperature is above the critical temperature (Mukhopadhyaya et al., 2005). The time of wetness is calculated using Equation 1.

$$TOW_{(i)} = \left(\sum_{h=i}^k t_{counter(i,h)} \right) \quad (1)$$

where:

- i is a spatial index for the considered part of the structure
- $t_{counter(i,h)}$ is the time of wetness, h

$$t_{counter(i,h)} = \begin{cases} = 1, & \text{if } T_{(i,h)} \geq 0^{\circ}\text{C and } RH_{(i,h)} \geq 80\% \\ = 0, & \text{else} \end{cases}$$
- $T_{(i,h)}$ is the temperature of the considered part of the structure, °C
- $RH_{(i,h)}$ is the relative humidity of the considered part of the structure, %
- k is the total sum of hours in a particular year.

The time of freezing (TOF) is defined as the total time of the month when the temperature is under the freezing point. The time of wetness and time of freezing of the rendering coat of the repaired facade from the year 2005 to 2010 are shown in Fig. 13.

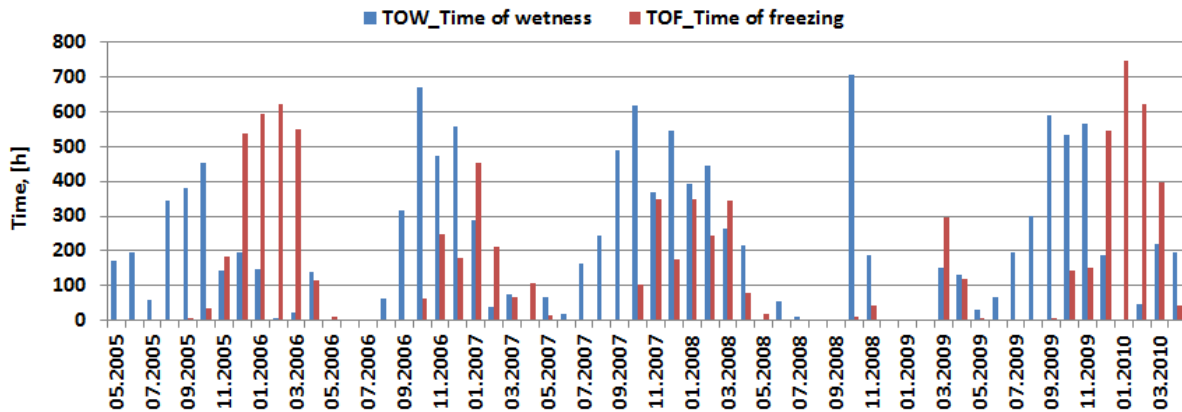

FIG. 13: The monthly time of wetness and time of freezing of the rendering coat of the repaired facade in the north-east direction - Point 5 in Fig.12 (b). There was a data loss during 08 – 09.2008 and 12.2008 – 02.2009 inclusive which affected the calculation of TOW and TOF during those periods.

It is easily observed that there is considerable variation in time of wetness and time of freezing during the monitoring period. The values of the time of wetness are used in calculating the time-dependent relative humidity and temperature RHTT index as shown in 4.3.

4.2 Drying of the original facade

Figure 14 shows the drying effect of the original outer concrete panel of the sandwich panel (see Point 4 in Fig. 12(b)) under the added external wall insulation and rendering system. The daily average relative humidity of the outer concrete panel dropped from 83% to 44% within the first year. During the year 2006 and 2010, the daily average relative humidity varies between 40% and 60%. The temperature of the original outer concrete panel remained above 0 °C for the majority of the time. These results indicate that the progress of reinforcement corrosion and frost deterioration of the original concrete facade has strongly decelerated or even stopped.

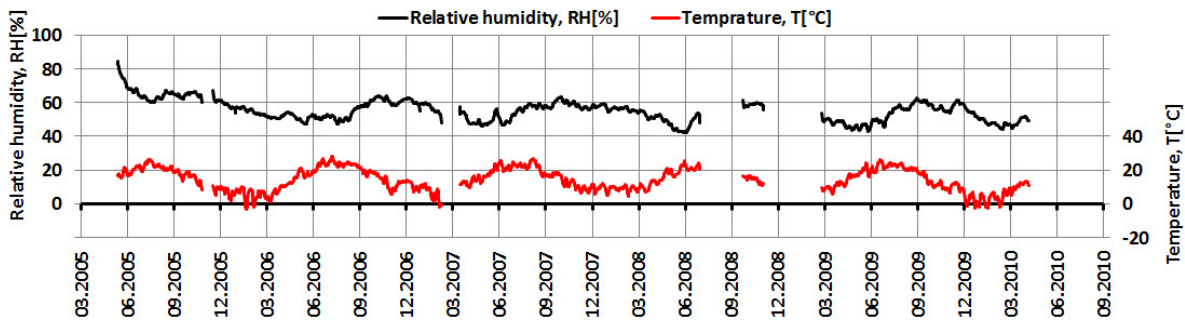

FIG. 14: The daily average temperature and relative humidity of the original outer concrete panel of the repaired facade in the north-east direction - Point 4 in Fig.12(b).The discontinuity in the two curves reflect missing data during four periods of time.

4.3 Time-dependent relative humidity and temperature RHTT index

According to Mukhopadhyaya et al. (2005), the RHTT index is defined as the potential for any moisture damage when prolonged high moisture levels and high temperatures occur simultaneously for an extended period of time. As shown in Equation 2, the RHTT index is defined as the product of the time of wetness (TOW) factor and the intensity of hygrothermal loading level in the structure by which the critical conditions are exceeded. The degree of moisture damage due to any of degradation mechanisms is directly proportional to the time-of-wetness (TOW) factor.

$$RHTT_{(i)} = TOW_{(i)} \times RHT_{(i)} \quad (2)$$

where:

- i is a spatial index for the considered part of the structure
- $TOW_{(i)}$ is the calculated time of wetness within the considered part of the structure, (h)
- $RHT_{(i)}$ is the intensity of hygrothermal loading level in the structure by which the critical conditions are exceeded.

The long-term moisture response indicator RHT index is calculated by multiplying the temperature ($T_{potential}$) and moisture ($RH_{potential}$), for moisture damage as shown in Equation 3.

$$RHT_{(i)} = \sum_{h=1}^k T_{potential(i,h)} \times RH_{potential(i,h)} \quad (3)$$

where:

- $T_{potential}$ is the potential temperature for moisture damage, °C

$$T_{potential(i,h)} \begin{cases} = T_{(i,h)} - T_{critical}, & \text{if } T_{(i,h)} > T_{critical} \\ = 0, & \text{if } T_{(i,h)} \leq T_{critical} \end{cases}$$
- $RH_{potential}$ is the potential relative humidity for moisture damage, %

$$RH_{potential(i,h)} \begin{cases} = RH_{(i,h)} - RH_{critical}, & \text{if } RH_{(i,h)} > RH_{critical} \\ = 0, & \text{if } RH_{(i,h)} \leq RH_{critical} \end{cases}$$
- $T_{critical}$ is the user-defined critical threshold value of temperature level above which moisture damage is more likely to occur, °C
- $RH_{critical}$ is the user-defined critical threshold value of relative humidity level above which moisture damage is more likely to occur, %

In this paper, RHTT1 and RHTT2 indices were calculated. The RHTT1 indices indicate the potential of biological deterioration, where the critical relative humidity is greater than 80% and the critical temperature is greater than 5 °C. The RHTT2 indices indicate the potential of reinforcement corrosion, where the critical relative humidity is greater than 80% and the critical temperature is greater than 0 °C.

The calculated values of the RHTT1 and the RHTT2 indices for the rendering coat of the repaired facade are shown in Fig. 15. The values of the RHTT1 and RHTT2 indices indicate low biological and corrosion damage potential due to thermal and moisture loading in the rendering coat. Although acceptable values for RHTT indices for various building materials are not available at the moment, the important feature of the RHTT index is that the higher RHTT index values indicate an increased severity of the hygrothermal response and higher damage potential.

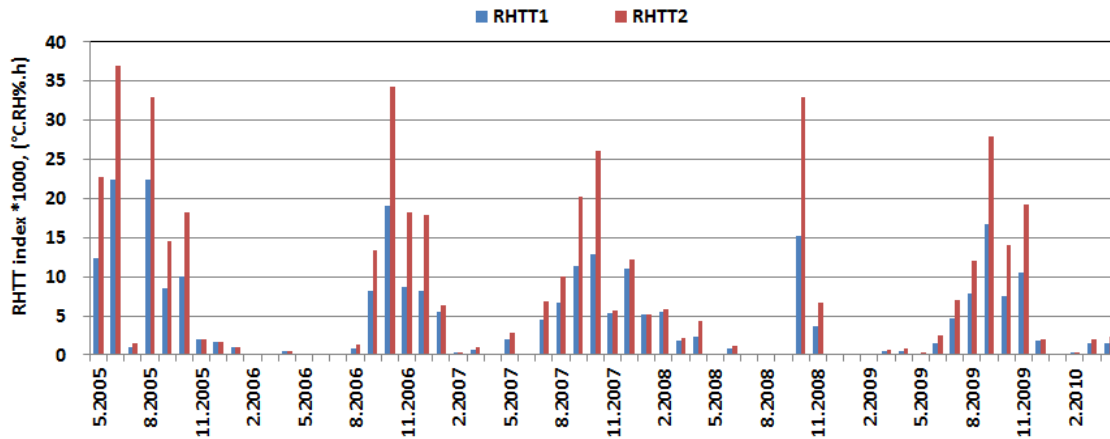

FIG. 15: The values of the RHTT1, the RHTT2 indices for the rendering coat of the repaired facade in the north-east direction - Point 5 in Fig.12 (b). There was a data loss during 08 – 9.2008 and 12.2008 – 02.2009 inclusive which affected the calculation of the RHTT indices during those periods.

4.4 Freezing thawing index

The freezing thawing index (FT) is defined as the number of freezing or thawing oscillations when the temperature oscillates around 0°C for those structures that are almost at the moisture saturation level, $RH_{critical}$ (Mukhopadhyaya et al., 2005). According to Fagerlund (2001), the critical moisture saturation level for concrete structures varies between 75% and 90%. The freezing thawing index is calculated using Equation 4.

$$FT_{(i)} = \sum_{h=1}^k Counter_{(i,h)} \quad (4)$$

where:

$Counter_{(i,h)}$ is a freezing or thawing oscillator when temperatures oscillate around 0°C

$$Counter_{(i,h)} = \begin{cases} = 1, & \text{if } T_{(i,h)} \times T_{(i,h-1)} < 0 \text{ and } RH_{(i,h)} \geq 80\% \\ = 0, & \text{else} \end{cases}$$

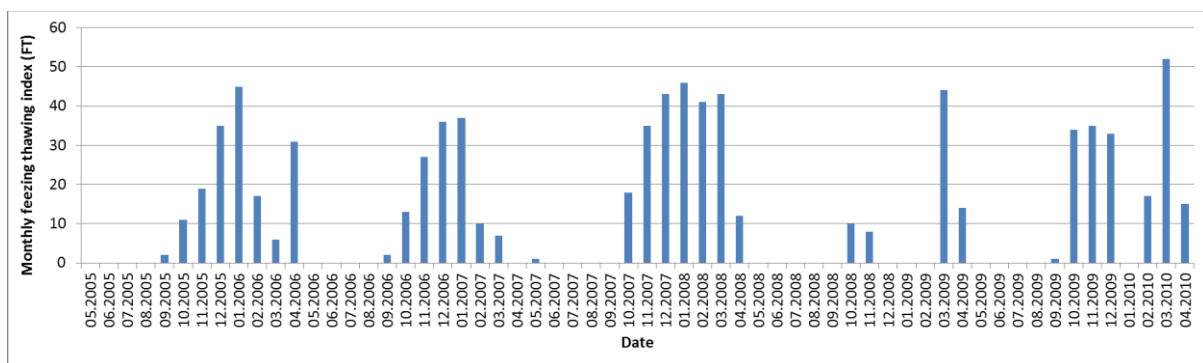

FIG. 16: The values of the freezing thawing index for the rendering coat of the repaired facade in the north-east direction - Point 5 in Fig.12 (b). There was a data loss during 11.2008 – 03.2009 which affected the calculation of freezing index during those periods.

The results of the freezing thawing index with critical moisture of 75% for the rendering coat of the repaired facade are shown in Fig. 15. The higher the number of cycles indicates the greater the potential for frost damage.

5. CONCLUSIONS

The need for a new method for monitoring of temperature and moisture in repaired building facades was recognized. Specifically, the new method should be non-destructive, yet able to measure the thermal and moisture conditions at exact and predefined locations inside the structure. The approach chosen to fill the defined need was the RHT-MNS monitoring network system that uses sensors and nodes that are embedded inside the building structures at the time of rehabilitation, and a controller connected to a host computer for reading the signals from the sensors.

The results of the thermal and moisture monitoring show drying of the original outer concrete panel after adding external wall insulation and rendering system. This study uses a long-term moisture response indicator called the RHTT index derived from the relative humidity and temperature values over a period of time for any specific area of the wall cross-section. Although acceptable values for RHTT indices for various building materials are not available at the moment, the important feature of the RHTT index is that the higher RHTT index values indicate an increased severity of the hygrothermal response and a higher damage potential. The freezing thawing index (FT) is defined as the number of cycles when the temperature oscillates between the freezing and thawing point for the facade components that are almost at the moisture saturation level. Increased freezing thawing index values indicate an increased severity of the frost action and a higher damage potential.

The relative humidity and thermal monitoring network system (RHT-MNS) has proven to be a successful new method for monitoring of temperature and moisture in repaired building facades. The RHT-MNS monitoring network system is also reliable, inexpensive, fast to assemble and easy to use which fulfil the requirements for a new monitoring method.

The deliverables of the relative humidity and thermal monitoring network system (RHT-MNS) consisted of two applications. One application for monitoring the relative humidity and thermal performance of building facades and another application which is under development, for theoretical prediction of the service life of building facades based on moisture and thermal originated damage functions.

The result of the research will improve the building construction industry by providing methodologies and systems for monitoring and predicting the performance of building facades. The scientific relevance of this research will be the improved correspondence between laboratory studies and observations of deterioration in practice.

6. REFERENCES

- Al-Neshawy, F. (2007). A network system for monitoring the thermal and moisture performance of repaired concrete facades. Thesis for the degree of Licentiate of Science in Technology. Department of structural engineering and building technology. *Helsinki University of Technology*. Espoo, Finland. 127 pages.
- Carmeliet, J., Roels, S. and Bomberg, M. T. (2009). Towards development of methods for assessment of moisture-originated damage. Chapter 28 in *Moisture control in buildings: the key factor in mold prevention*, MNL18-2nd, edited by Heinz R. Trechsel and Mark Bomberg-2nd ed., *ASTM international*. pp. 591-605
- Fagerlund, G. (2001). CONTECVET (IN30902I): Manual for assessing concrete structures affected by frost. *Lund University, Department of building and environmental technology*, Sweden. 202 pages.
- Huovinen, S., Bergman, J. and Hakkarainen, H. (1998). Deterioration defects and repair methods of facades, Laboratory of structural engineering and building physics, *Helsinki University of Technology*. Espoo, Finland. Report 78. 69 pages.
- Karagiozis, A.N. (2002). Building Enclosure Hygrothermal Performance Study Phase I. *ORNL/TM-2002/89*, Oak Ridge National Laboratory, Oak Ridge, TN. 162 pages
- Lindblom-Patkus, B. (2007). Monitoring temperature and relative humidity. *Northeast document conservation centre*. Online at: http://www.nedcc.org/resources/leaflets/2The_Environment/02TemperatureAndHumidity.php [Accessed 28.10.2010].
- Linnet Oy Ltd. (2007). Commercial home network technology. Online at: <http://www.linnet.fi/html/network.html> [Accessed 05.03.2011].
- Moodi, F. (2004). Integration of knowledge management and information technology into the repair of concrete structures: an innovative approach', *The international journal of information technology in architecture, engineering and construction (IT-AEC)*, Issue 3, Vol. 2, CICE, Loughborough University, UK.
- Mukhopadhyaya, P., Kumaran, K., Nofal, M., Tariku, F. and van Reenen, D. (2005). Assessment of building retrofit options using hygrothermal analysis tool. *The proceedings of the 7th symposium on building physics in the Nordic countries*, Reykjavik, Iceland, 13–15 June, 2005, pp. 1139-1146.
- Norris, A., Saafi, M. and Romine, P. (2008) Temperature and moisture monitoring in concrete structures using embedded nanotechnology/microelectromechanical systems (MEMS) sensors. *Construction and building materials*, 22 (2008), pp. 111–120.
- Räisänen, P. (2005). Real time monitoring of building deterioration by material resistance measurement (in Finnish). Master thesis. *Helsinki University of Technology*. Espoo, Finland. 168 pages.
- Sensirion AG, (2007). Data sheet for the humidity sensor SHT15. Online at: http://www.sensirion.com/en/01_humidity_sensors/00_humidity_sensors.htm [Accessed 05.03.2011].
- Voutilainen, J. (2005). Methods and instrumentation for measuring moisture in building structures. Dissertation for the degree of Doctor of Science in Technology, Department of Electrical and Communications Engineering, *Helsinki University of Technology*. Espoo, Finland. 157 pages.