

TOWARDS DIGITAL FACILITY MODELLING FOR SYDNEY OPERA HOUSE USING IFC AND SEMANTIC WEB TECHNOLOGY

SUBMITTED: February 2007

REVISED: June 2007

PUBLISHED: July 2007 at <http://itcon.org/2007/24/>

EDITOR: B-C Björk

*Hans Schevers, Post-doctoral research fellow
CSIRO Sustainable Ecosystems, Highett, Victoria, Australia
email: Hans.Schevers@csiro.au*

*John Mitchell, Associate professor
University of New South Wales, Sydney, Australia
email: johnmi@fbe.unsw.edu.au*

*Paul Akhurst, Director Facilities
Sydney Opera House, Bennelong Point, Sydney, Australia
email: PAkhurst@soh.nsw.gov.au*

*David Marchant, IT Manager Global
Woods Bagot, Sydney, Australia
email: david.marchant@woodsbagot.com.au*

*Stuart Bull, BIM Coordinator
Arup, Level 10, 201 Kent St, Sydney NSW 2000, Australia
email: Stuart.Bull@arup.com.au*

*Kevin McDonald, Software engineer
CSIRO Sustainable Ecosystems, Highett, Victoria, Australia
email: Kevin.McDonald@csiro.au*

*Robin Drogemuller, Team leader Urban Informatics
CSIRO Sustainable Ecosystems, Highett, Victoria, Australia
email: Robin.Drogemuller@csiro.au*

*Chris Linning, Technical Information Coordinator
Sydney Opera House, Bennelong Point, Sydney, Australia
email: clining@sydneyoperahouse.com*

SUMMARY: *The challenges of maintaining a building such as Sydney Opera House are immense and are dependent upon a vast array of information. The value of information can be enhanced by its currency, accessibility and the ability to correlate data sets (integration of information sources). A building information model correlated to various information sources related to the facility is used as definition for a digital facility model. Such a digital facility model would give transparent and an integrated access to an array of datasets and obviously would support Facility Management processes. In order to construct such a digital facility model, two state-of-the-art Information and Communication technologies are considered: an internationally standardized building information model called the Industry Foundation Classes (IFC) and a variety of advanced communication and integration technologies often referred to as the Semantic Web such as the Resource Description Framework (RDF) and the Web Ontology Language (OWL). This paper reports on some technical aspects for developing a digital facility model focusing on Sydney Opera House. The proposed digital facility model enables IFC data to participate in an ontology driven, service-oriented software environment. A proof-of-concept prototype has been developed demonstrating the usability of IFC information to collaborate with Sydney Opera House's specific data sources using semantic web ontologies.*

KEYWORDS: *facility management, digital facility model, IFC, ontology, semantic web.*

1. INTRODUCTION

Sydney Opera House is a unique building, an icon of 20th century architecture and an iconic symbol of Sydney and Australia. The challenges of maintaining such a building are immense and are dependent upon a vast array of information that begins with as-built documents, Operation & Maintenance manuals, and extends to include maintenance schedules, room data sheets, asset performance data, cost data, etc. Obviously the value of this information for facility management is enhanced by its currency, accessibility and the ability to correlate one data set with another (integration of datasets) (Ballesty et al 2006). A building information model correlated to these information sources is used as definition for a digital facility model. Such a digital facility model would give transparent and an integrated access to the available information and opens up capabilities for information logistics (the right information, on the right time, on the right spot, in the right format).

In order to construct such a digital facility model, two state-of-the-art Information and Communication technologies are considered: 1) a standardized building information model called the Industry Foundation Classes (IFC) (IAI 2006) and 2) a variety of advanced communication/integration technologies often referred to as the Semantic Web (Berners-Lee et al 2001) such as the Resource Description Framework (RDF) and the Web Ontology Language (OWL) (Fensel 2002).

The following section 'Facility Information Systems at Sydney Opera House' will discuss the existing information systems at Sydney Opera House and highlight the potential benefits of digital facility models. The 'Software Technology for Digital Facility Models' will discuss the key technologies available today to implement a digital facility model. The section 'Towards Digital Facility Modelling for Sydney Opera House' will discuss the developed prototype software system.

2. FACILITY INFORMATION SYSTEMS AT SYDNEY OPERA HOUSE

Several software information systems and agreement practices are present at Sydney Opera House (SOH) supporting consistent information management for Facility Management purposes. This section discusses a couple of these systems.

2.1. SOH Building Coding System

SOH has introduced a spatial breakdown of the building using Location Zones, Functional Spaces, Storeys and Rooms. The SOH complex comprises of several Location Zones which contain Functional Spaces which contain several rooms (FIG. 1). Another breakdown of SOH is based on the primary function of a set of rooms called Functional Spaces. A more straightforward breakdown is based on storeys.

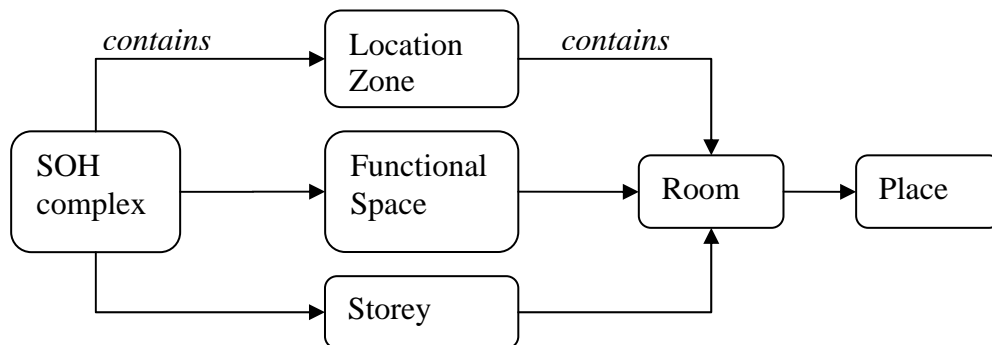

FIG. 1: Overview of SOH spatial decomposition. The SOH complex can be subdivided into LocationZones or FunctionalSpaces or Storeys. All these spaces contain rooms which may have several places (a specific part of a room).

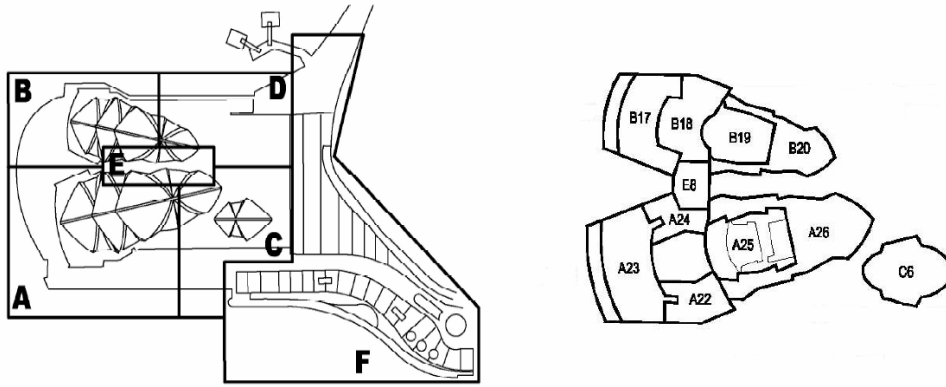

FIG. 2: Shows the spatial break-down of SOH including the site and the remote facilities into Location Zones and Functional Spaces.

The Functional Spaces have their code and names and contain several rooms. Table 1 gives some examples of the functional spaces of SOH.

TABLE 1: some examples of functional space coding system

CODE	Name	contains
BX	Box Office	Box office, Call centre, Tours Office, Box office foyer including cloakrooms, toilets, stairs from forecourt
CH	Concert Hall	Auditorium including walls & ceilings, platform, backstage, control rooms, roof space (not shells), foyers, rehearsal & dressing rooms
CP	Central Passage	Stage door, central passage and bronze vehicle doors

To uniquely identify each room in SOH, each storey is named and each room has a unique number. For example the storey code GM stands for Ground Mezzanine and GM574A is the Upper Plant room (574A) on the Ground Mezzanine floor.

TABLE 2: Breakdown of Sydney Opera House into elements and its coding system

Level 1	Level 2 (functional space)	Level 3 (element)	Level 4 (sub-element)	Level 5 (component)	Plant ID	Parent ID	Element Code
Sydney Opera House					2467	-	0000
	Concert Hall	Stage Audio			1313	2535	5200
			Amplifiers		1320	1313	5201
			Cabling		1327	1313	5202
			Sound console		4234	1313	5204
			Public address		1383	1313	5210
	Building General				3971	2467	0018
		Gas Service			0772	2467	2000
			Meters		0776	0772	2002
			Pipework		0778	0772	2003
		Central Plant			0779	2467	2300
			Chillers		0781	0779	2302
			Sea water		0783	0779	2304
				Pump no. 1	4667	0783	2304
				Pump no. 2	4668	0783	2304
				Pump no.3	4669	0783	2304

Similarly the building is broken down into a series of elements, sub-elements and components in a hierarchal plant structure. Each item has its own unique identifying number. The top level of the structure is Sydney Opera House itself and the second tier the functional spaces, which are then followed by elements, sub-elements and components (Table 2). Through the second tier of functional spaces the plant structure is linked back to the spatial structure. Future generations of the databases will allow parallel spatial and plant structures (such as the newly installed Mainet system, formerly known as Mainpac). The plant structure enables maintenance tasks, costs, conditioning monitoring and other data to be planned and recorded against individual elemental or component items.

2.2. SOH benchmark databases

To measure the building performance of Sydney Opera House, several instruments have been developed and implemented (Sydney Opera House 2005). One of these instruments is the Building Condition Index which is a combination of a Building Fabric Index (BFI) and a Building Presentation Index (BPI). The BFI and the BPI are methods to measure general appearance, tidiness and cleanliness of rooms of the building. Guidelines have been developed to rate objects in rooms in the building by scoring them manually (FIG. 3).

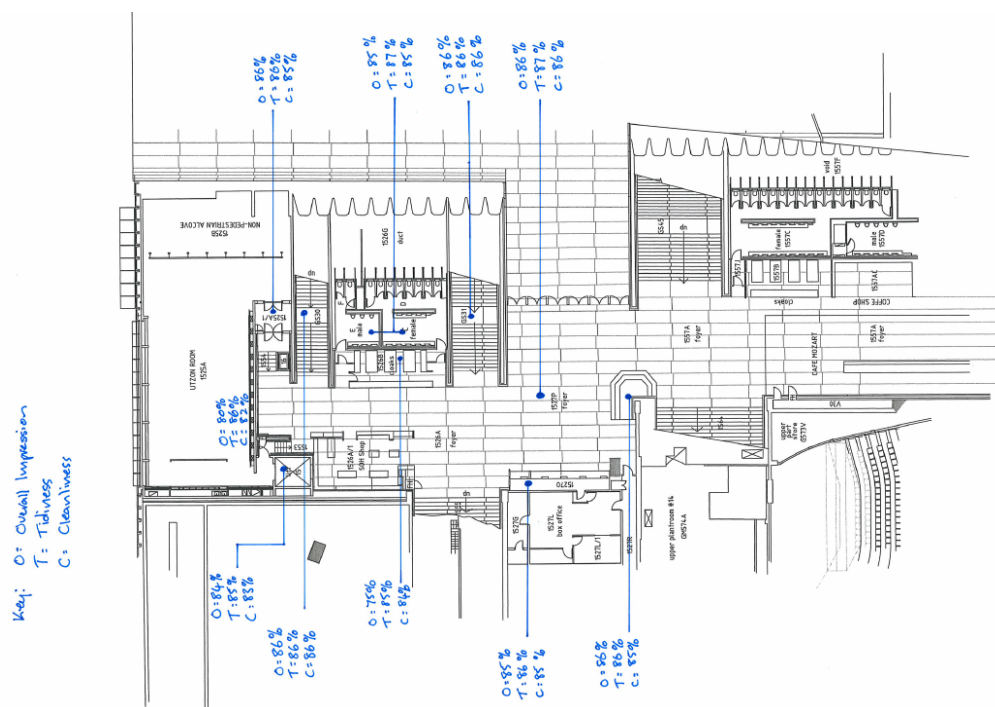

FIG. 3: Benchmarking objects in SOH. 2D layout drawings are used to keep track of the benchmarks

These scores can be aggregated to get a total score per room which can be aggregated again to get a total score per zone. Keeping track of these scores in databases by using unique identifiers for each object enables SOH to investigate how changes such as new cleaners or different cleaning contracts affect the building performance. Obviously this helps SOH to keep track of their building performance on a daily basis but also to make/evaluate strategic decisions.

2.3. Software Information Systems

Several information systems regarding the facility are present at SOH. The following list gives an example of the available systems. FIG. 4 shows the relationships between the systems regarding information correlation.

- MAINPAC/MAINET, Maintenance planning and tracking.
- HARDCAT Asset Register which monitoring the value of the asset at any given time by using depreciation rates to calculate current value.

- SAM Budgeting TAM Manager System. Setting up and monitoring of major and regular works budgets, order commitments and actual spend. Ensures that projects are completed within the allocated budget.
- Sun Corporate Financial system for accounting.
- TRIM Business document management tool.
- Technical Document access.
- Intranet providing access to SOH technical information.

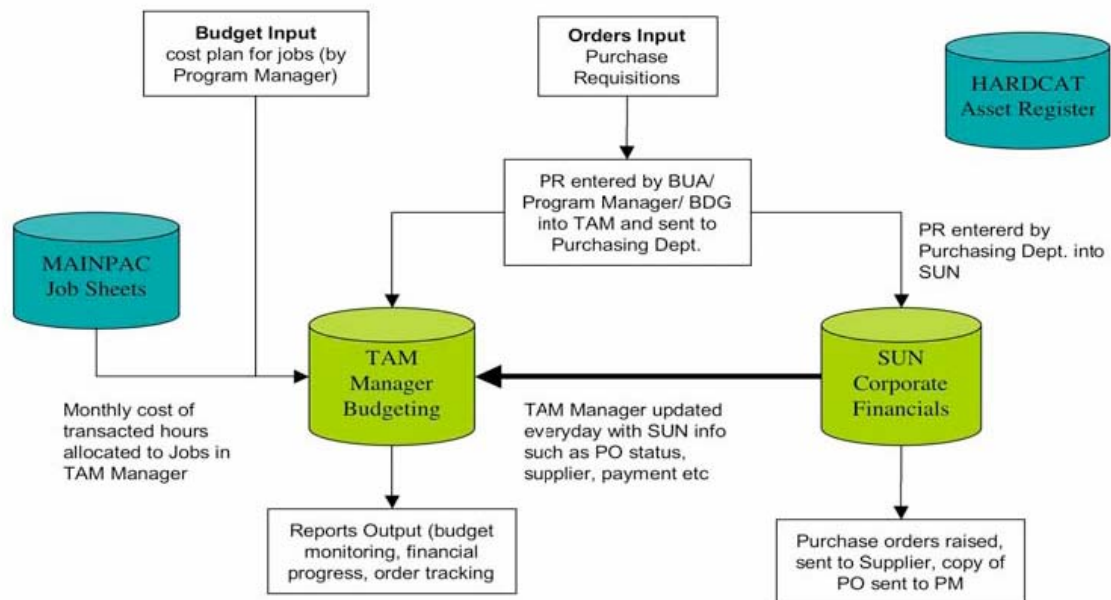

FIG. 4: Information systems in place at SOH and their correlations

Already several information sources are linked providing a more integrated information base. For example SOH Enterprise Resource Planning system (Sun Corporate Financials) updates the TAM manager with purchase order status (payments for example).

2.4. Towards a Digital Facility Model for SOH

The objective of SOH is to build up an accurate, reliable, and relevant integrated building model of Sydney Opera House. This model should contain various information sources in order to support operational management, building and service system alterations/additions, asset and maintenance management, etc. For example the digital facility model should facilitate data mining exercises for strategic analyses and the model should facilitate various operational FM processes such as maintenance planning, room scheduling, provide insights in building performances, etc.

Introducing a full scale Facility Management System is hardly feasible or desirable. A more evolving approach is necessary where the digital facility model evolves from a relatively simple information system to a more integrated and knowledge intensive system. Flexibility of such an information system is necessary to cope with changing business demands coming from changing business goals or different FM processes and/or technology, etc. Ideally, the digital facility model should be the integrated data source for all information systems at SOH. This means that when one information system processes or changes some data, all other systems are aware of that change eliminating information redundancy. Such an integrated information model opens up the way for more automated intelligence in the model incorporating rules and best practices. For example planning support or even optimisation can be envisioned.

3. SOFTWARE TECHNOLOGY FOR DIGITAL FACILITY MODELS

3.1. Standardized Building Information Model

An international standard for data exchange for Building Information Model (BIM) data has been available for a while called the Industry Foundation Classes (IFC) (IAI 2006). The IFC is based upon the ISO-10303 EXPRESS product modelling standards and was released by the International Alliance for Interoperability (IAI) in 1997. The goal of the IFC is to enable interoperability between Building Information Systems. The principal difference between BIM and 2D CAD is that the latter describes a building by independent 2D views (drawings), e.g. plans, sections and elevations. Editing one of these views requires that all other views must be checked and updated if necessary, a clumsy and error prone process that is one of the major causes of poor documentation today. In addition, the data in these 2D drawings are graphical entities only, e.g. line, arc circle, etc. in contrast to the intelligent semantic of BIM models, where objects are defined in the terms of building parts and systems eg spaces, walls, beams, columns, etc. The capacity for whole facility life cycle management has been a central concept in the IFC model specification. The core model is a rich description of the building elements and engineering systems that provides an integrated description for a building. This feature together with its geometry (for calculation and visualisation), relationships and property capabilities underpins its use as an asset and facility management database. Besides this core IFC schema other schemas are present which are directly linked to the core schema. This layered approach reduces the complexity of the whole extended IFC schema. The potential advantages of using an open standard are:

- IFC enable re-use of Building Information through out the whole building lifecycle.
- IFC is model-driven and a semantically rich model.
- Information can be read and manipulated by any compliant software and thus reducing the user “lock-in” to proprietary solutions.
- IFC content can be provided by almost all major CAD systems enabling different parties to contribute to the model such as different architect firms, constructors, structural engineers, etc.
- IFC focuses on the whole building lifecycle and therefore it is a very integrated dataset for any modification or analyses of the building. For example IFC data can be used as input for Energy consumption simulations.
- Third party software can be the “best of breed” to suit the process and scope at hand making the IFC information ‘the asset’ and not so much the software programs.
- Standardised BIM solutions consider the wider implications of information exchange outside the scope of any particular vendor, information can be archived as ASCII files for archival purposes, and data quality can be enhanced as the now single source of users’, information has improved accuracy, correctness, currency, completeness.

3.1.1. IFC for Facility Management

The IfcSharedFacilitiesElements Schema defines basic concepts in the facilities management (FM) domain. This schema, along with IfcProcessExtension, IfcSharedMgmtElements and IfcFacilitiesMgmtDomain, provide a set of models that can be used by applications needing shared information concerning facilities management related issues. The schema supports concepts including:

- Furniture.
- Grouping of elements of system furniture into individual furniture items.
- Asset identification.
- Inventory of objects (including asset, furniture and space objects within separate inventories).

The IfcFacilitiesMgmtDomain captures business processes information within the domain of interest of the Facilities Manager. The aim is to support interoperability between computer aided facilities management and computer aided maintenance management applications. Currently the extent of the model will not support the some of the more detailed ideas found in these applications. The following are within the scope of this part of the specifications:

- Managing the movement of people and their associated equipment from one place to another. All types of move are considered to be within scope: ranging from moving a single person from one office to another to the movement of complete organizations between locations.

- Capturing information concerning the condition of components and assets both for subjective and objective assessment of condition.
- Recording the assignment of permits for access and carrying out work.
- Capturing requests for action to be carried out and the assignment of work orders to fulfil the needs expressed by requests.

The following are outside of the scope of this part of the specifications:

- Work interactions between actors and between space programs.
- Moving or identifying the movement of or identifying the need for (as a result of moving) electrical or telecommunications services or connection points or the need for new electrical or telecommunications equipment as a result of the move.
- Facilities management standards other than space, furniture and equipment.

3.1.2. IFC Compliant Software

Currently the IFC is supported by the major Computer Aided Design (CAD) systems such as ArchiCAD, AutoDesk AutoCAD Architectural Desktop, REVIT, Allplan, Bentley Microstation Triforma, etc. This enables these systems to import and export building information including the geometry. Besides 3D viewers capable of viewing IFC files, several IFC compliant applications for assessing the building descriptions are emerging: for example the automated code checking (Ding et al 2006), automated cost estimation or Construction Planning (Rischnmoller et al 2000) (Trinidad et al 2004).

Besides these domain specific applications, more general IFC tools are available as well such as databases capable of storing IFC files enabling multi user access. The EDM database also supports schema visualisation and rules working with the IFC data. In the Facility Management domain several software packages are emerging such as FIS, Rambyg, FM:Systems, Vizelia, Rhyti, etc.

From a software point of view, the first generation of IFC compliant FM systems is available. Most of these systems are quite new and do not have the history of the long-time available 2D based FM implementations such as Archibus. Currently only a small part of the IFC model is being used and not all functionality of the FM BIM is currently exploited.

3.1.3. Evaluation of IFC for Digital Facility Modelling

The following can be concluded:

- IFC offers interoperability between CAD systems and other systems enabling re-use of building information though the FM part of the IFC is hardly supported.
- The IFC model is extensible though in a limited way. Data is really based on the schema. Tampering with the schema might result in loss of data. Therefore the flexibility has to come from available constructs in the schema like the ProxyObject or property sets. This can be a bit limited and does not take advantage of customized schema models have to offer.
- Connections with other information sources such as relational databases have to be developed on an ad-hoc basis.

3.2. Semantic Web Technology

3.2.1. Semantic Web

Semantic Web is a vision of the next generation of the internet focusing on making data more machine-processible (Berners-Lee et al 2001). Machine processible data increases the value of the data as it is easier to re-use it. From a service oriented software architecture view, web services using this machine-processible data can use each other's data more easily resulting in chains of web services performing more intelligent tasks. This emerging Semantic Web relies on ontologies which are 'an explicit specification of a conceptualization' (Gruber 2003). Data can be processed by using these ontologies enriching relationships in the data which opens up the ability for further processing. The idea is that these ontologies reside on the (intra) web so that they can link to each other and re-use ontological elements. A network of ontologies could emerge enabling data sources to be linked. The network of interrelated ontologies can form the basis for interoperable web services resulting in a Service Oriented Architecture (SOA) (Daconta et al 2003). SOA enables loosely coupled software applications to collaborate as if they were one application. The fact that they are loosely coupled eases the maintenance of the total system and makes changes in the network easier offering flexibility and (unexpected) re-use. For example,

new services can be introduced without interfering with the existing network of services; new services can be composed using the existing ones, etc.

The W3C community has standardized a Web Ontology Language (OWL) (Smith et al 2004). This language allows you to specify classes, properties, relationships, constraints, etc. Data can be checked if it complies with these definitions. Ontologies can use each other's classes and properties and extend them without tampering with the parent classes. When software applications and databases are able to communicate using this OWL format, relations can be made between ontologies to improve the interoperability (FIG. 5). The loosely coupled approach allows you to change individual components relatively easily while inference supports will help to keep the whole system consistent.

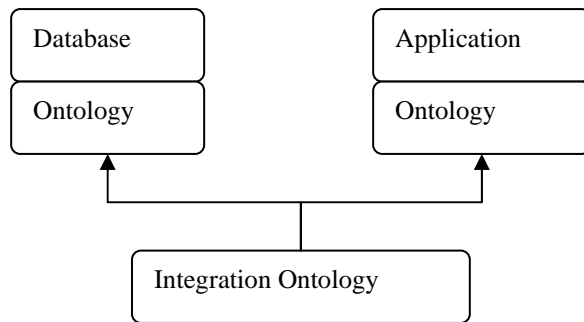

FIG. 5: A network of ontologies supports interoperability while the service oriented architecture supports flexibility and extendability.

3.2.2. Network of Ontologies for Digital Facility Modelling

Semantic Web technology seems ideal for integration of non-homogenous databases and applications using the service oriented architecture. An integration ontology focusing on SOH specific business needs can be constructed using ontologies from data sources such as the TAM manager, room planning data, asset databases, etc. Ideally each data source has its own ontology describing its data in meaningful objects. For example, an asset ontology can be made distinguishing between different asset objects such as an elevator, table and a fire extinguisher (FIG). Each asset object has certain generic properties and relations and can have their own properties and relations. In addition 'necessary and sufficient' restrictions can be used supporting automated classification of objects. For example 'Non-valid extinguishers' are extinguishers with the value 'false' for the property 'isValid'. Though a trivial example, the system now can distinguish between valid and non-valid extinguishers automatically. This is handy to organise knowledge intensive algorithms and rules. For example non-valid extinguishers need to be treated differently than valid extinguishers.

An 'integration ontology' relates the various ontologies to construct a complete view of all the ontologies. The flexibility and extendibility of the ontology approach is very appealing. SOH can create their own (integration) ontologies focusing on their business specific needs. Changes can be handled relatively easily offering flexibility for future requirements. New data sources and applications can be inserted and connected to the network of ontologies enabling extendibility and offering an evolutionary introduction of SOH digital facility model.

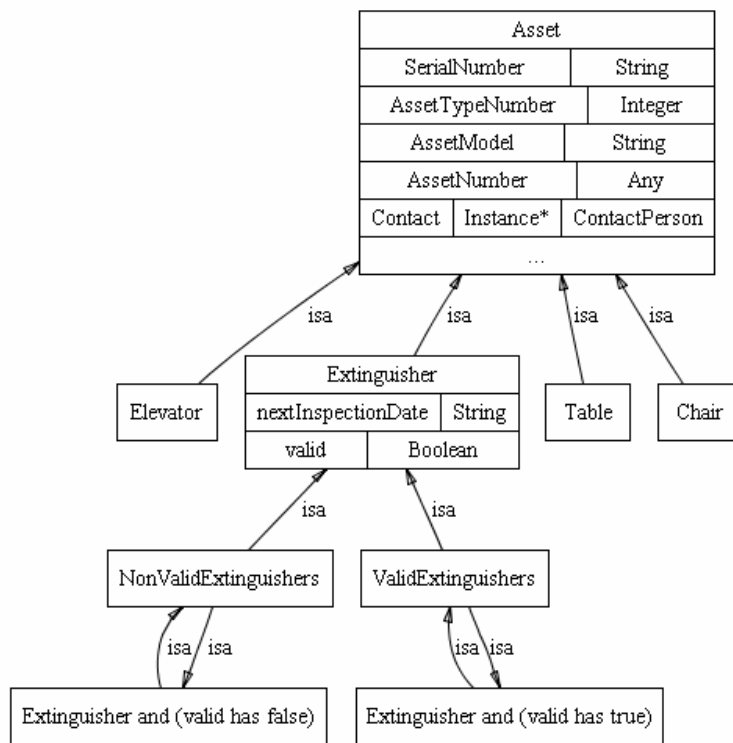

FIG. 8: Object presentation of a simple OWL-ontology describing Asset Objects.

3.2.3. Evaluation Semantic Web

The Semantic Web approach supports a service oriented architecture where individual software systems can collaborate by chaining semantic web services together when their ontologies are aligned. This extendable and flexible architecture allows new services to be added contributing to the whole and new services can be composed by different network configurations. The whole Semantic Web SOA architecture relies on ontologies which enable inference and interoperability between heterogenous software systems.

Ontologies capturing SOH specific business needs such as the spatial decompositions, benchmarking data, room planning data can easily be captured in ontologies. The OWL ontologies can help to check data consistency and even consistencies of the network of ontologies.

Though the Semantic Web vision is quite appealing, the current software for realising this is hardly mature. Simply not many (FM) software systems are compliant with this technology. In addition hardly any connections are available with Building Information Models. Certain CAD systems are starting to output some Semantic Web related technology though it is hardly available.

3.3. Discussion

The authors of this paper believe that a digital facility model for SOH should be as compliant as possible with IFC models in order to take advantage of emerging IFC compliant applications. Tampering with IFC schema or developing proprietary IFC extensions might reduce compliancy with the IFC and therefore should be avoided. For relating various data sources such as the asset register database, room planning data, TAM manager, benchmark data, the Semantic Web offers a scalable and flexible interoperability platform using the ontologies approach in combination with a service oriented architecture. Also from a software architecture point of view, it seems that the Service Oriented Architecture supports scalability and flexibility which is necessary to gradually introduce a digital facility model which can cope with changing business and FM processes.

4. TOWARDS DIGITAL FACILITY MODELLING FOR SYDNEY OPERA HOUSE

4.1. Digital Facility Model System

4.1.1. Conceptual Architecture

Ideally, the conceptual architecture is a service oriented architecture where different information sources are connected using Semantic Web ontologies and Webservices (FIG. 6).

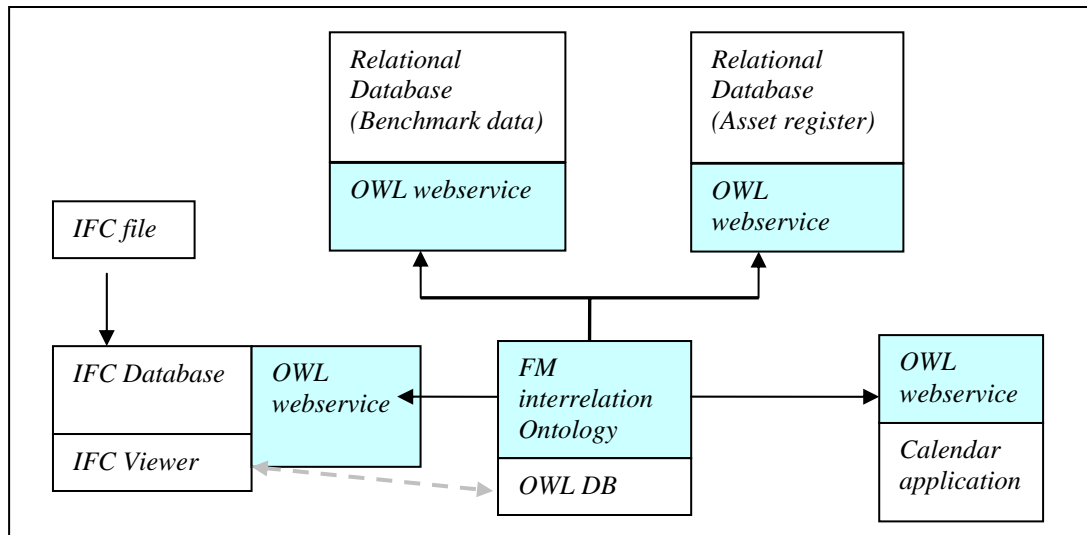

FIG. 6: Conceptual architecture for Sydney Opera House digital facility model.

The Semantic Objects in an IFC model are converted to an ontology using CSIRO's IFC-OWL work (Schevers & Drogemuller 2005). Benchmark ontology is created sitting on top of a benchmarking database. Script rules have been developed on top of OWL for aggregating Benchmark scores (Schevers 2004). Asset objects can now become subtypes of benchmark objects which will result in taking the objects into account when calculating the aggregate score (FIG. 7).

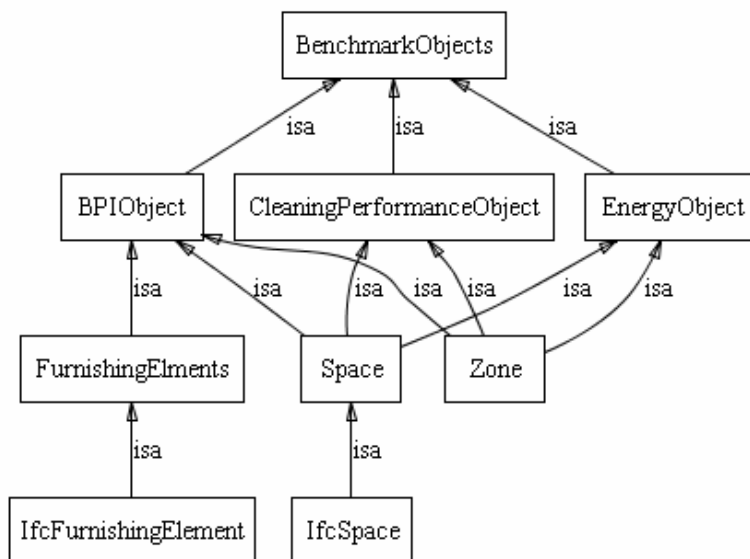

FIG. 7: Benchmark objects and its subtype objects. The benchmark ontology defines space (of the SOH ontology) to be a BenchmarkObject (CleaningPerformanceObject) and therefore all Space objects have the necessary benchmark properties and relations.

4.1.2. Network of Ontologies

The core SOH model contains objects able to deal with the spatial decomposition. So SOH contains ‘Storeys’ but also ‘Zone’ objects. These objects contain Spaces, etc. Subtypes of spaces can be developed such a Canteen, Office, Corridor, etc (FIG. 8). This ontology is directly based on the internal decomposition of SOH.

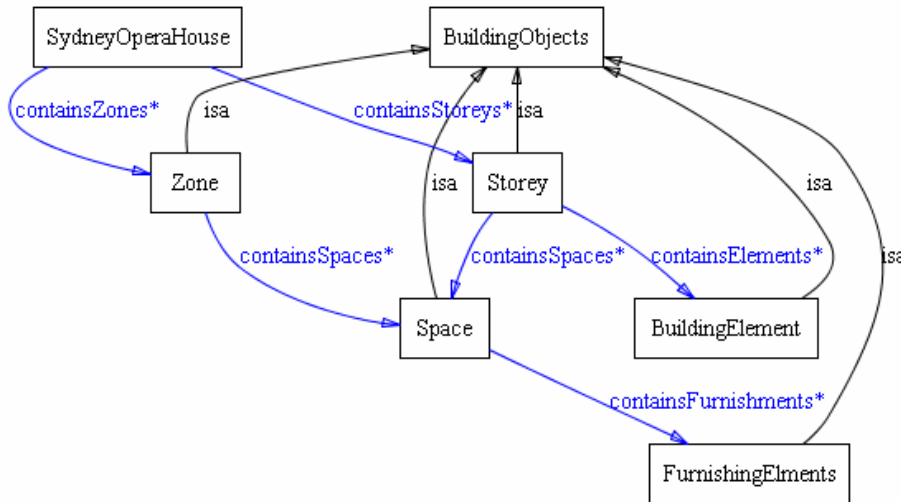

FIG. 8: Snapshot of SOH model. SOH specific objects such as SydneyOperaHouse, Zones and Spaces can capture SOH’s decomposition.

In order to link this SOH’s specific ontology to IFC data, subtyping is used. The IFC ontology is imported in the integration ontology containing the IFC semantic objects. SOH’s building element is used as super type for IFCBuilding element (FIG. 9). Now IFCbuildingElements are subtypes of BuildingElement in SOH’s core ontology and have SOH’s specific properties and relationships! Similarly IFCAsset objects (with geometry and location information) are subtyped of SOH specific Assetobjects. Now SOH’s asset objects are linked to IFC information.

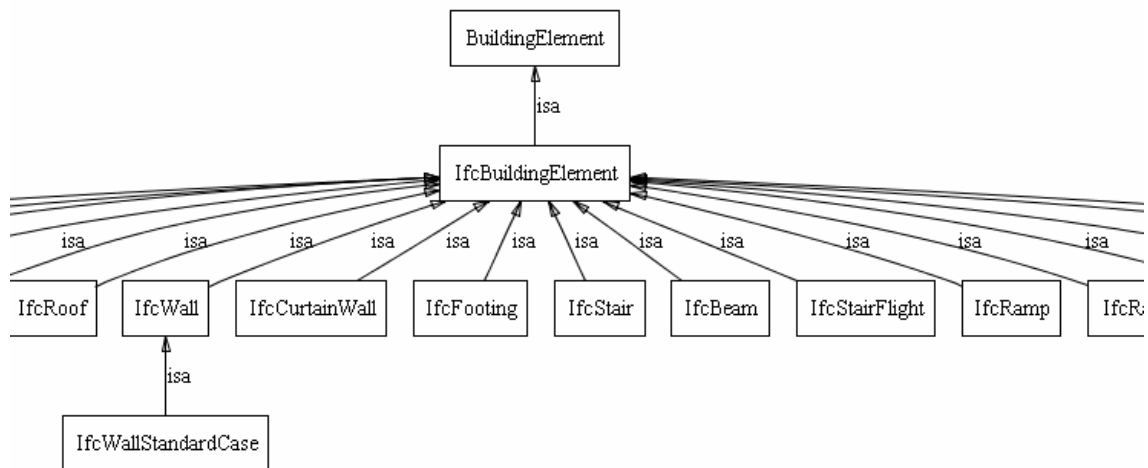

FIG. 9: Snapshot of the integration ontology where IFC ontology objects are specified as subtypes of the SOH core model. IFCBuildingElements within the IFC model are now BuildingElements in the SOH specific model.

Using rules, IFC data can be massaged to fit the SOH core schema. For example IFC elements which are relatively placed from IFCStorey (via the IFCLocalPlacement objects) can be linked directly using a SOH specific relationship between Storey and BuildingElement (FIG. 10).

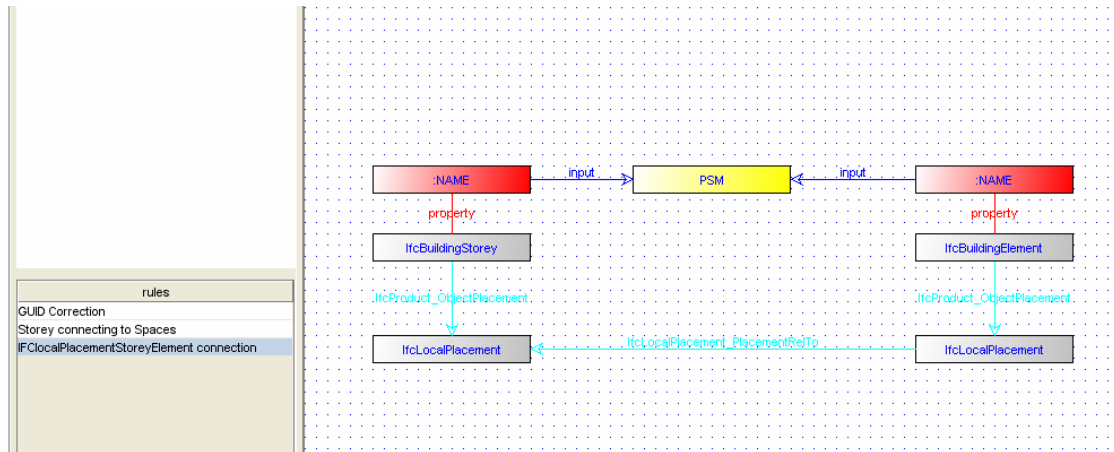

FIG. 10: A scriptrule searching for IFCBuildingElements which are relatively placed using IFCLocalplacement to IFCBuildingStorey.

A benchmark ontology has been developed specifying benchmark objects and rules to aggregate scores. Making these objects supertypes of asset objects from the asset ontology enables the rules to apply on these asset objects. So a chair can become a subtype of a cleaning benchmark object with a property BPIScore. This means that the chair will have this property and that this property value will be used to calculate the BPI score for the room which contains the chair. The flexibility of OWL enables changes to the schema without losing data. Existing furniture objects like Tables can be defined as a subtype of AssetObjects by simply adding a new OWL statement. This will result in the fact that Tables will be included in the whole benchmark process!

4.2. Prototype

4.2.1. Architecture and Implementation

A proof-of-concept implementation has been made where different ontologies are combined using the integration ontology. For the prototype, a simple OWL file-based transaction approach has been chosen. The integration ontology imports all OWL files and relates them into one ontology using Protégé (2005). The IFC file of SOH is using the CRC-CI IFCViewer (Drogemuller 2004) and links with the OWL IFC file by using the IFC's unique IDs. Hopefully this architecture can become distributed using technologies like RDFGateway, D2RQ connection and SPARQL queries.

4.2.2. IFC data of SOH

Arup has made a 3D model of a large part of SOH using Bentley Triforma for structural analysis. This model has been exported into an IFC file and has been imported into Archicad in order to insert IFCspace objects (including geometry). This was necessary as the structural model (only) contained objects relevant for structural analysis such as beams, floors, stairs and load bearing walls. Besides the insertion of extra spaces, SOH ID codes have been inserted in several elements in order to be able to link it to other data residing in the ontology (FIG. 11).

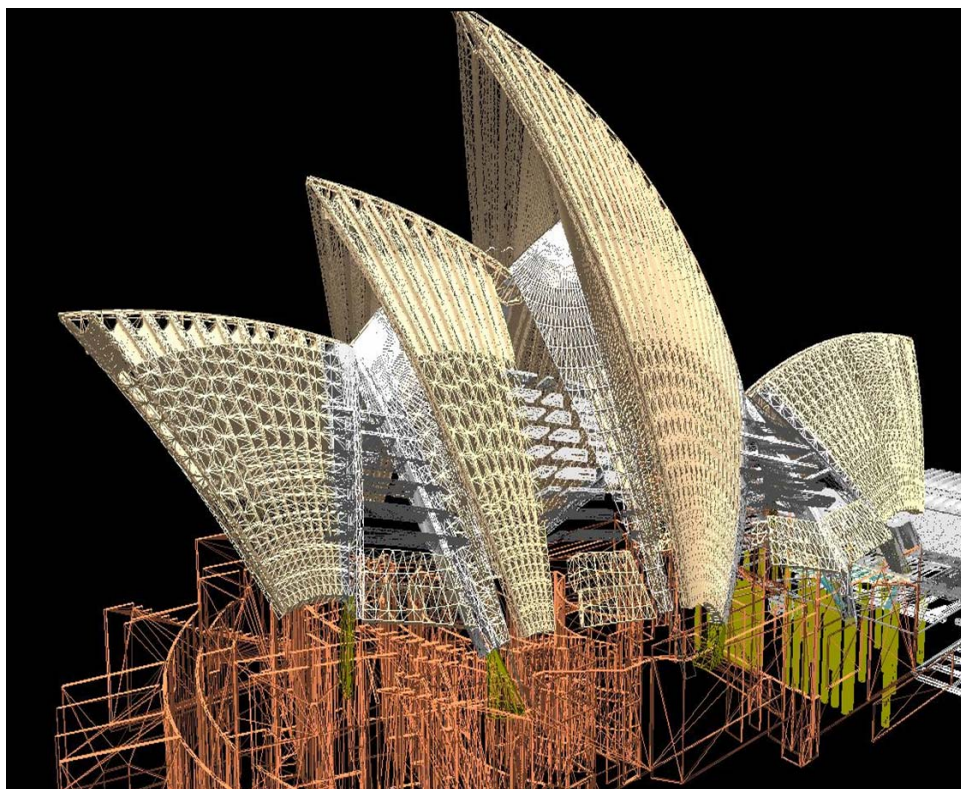
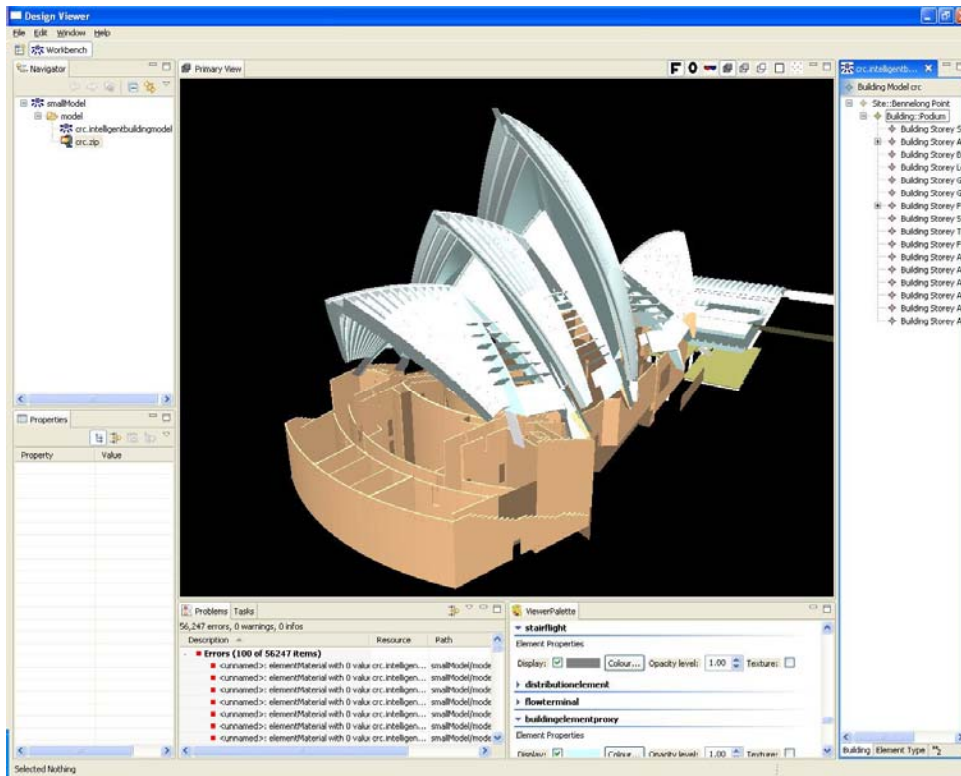

FIG. 11: Screenshots of the SOH IFC model including objects like beams, floors, roofs, spaces and their relations.

4.2.3. Result

The OWL-IFC coupling with the IFCViewer allows you to browse the SOH specific ontology by using the IFCViewer. SOH spatial decomposition can be used in a tree view while maintaining a link with the geometry data in the IFCViewer (using the IFC IDs). Additional properties for benchmark objects are available which can be used for querying or visualisation. For example, a query searching for all benchmark objects with a certain value (or higher) can be visualised (FIG. 12).

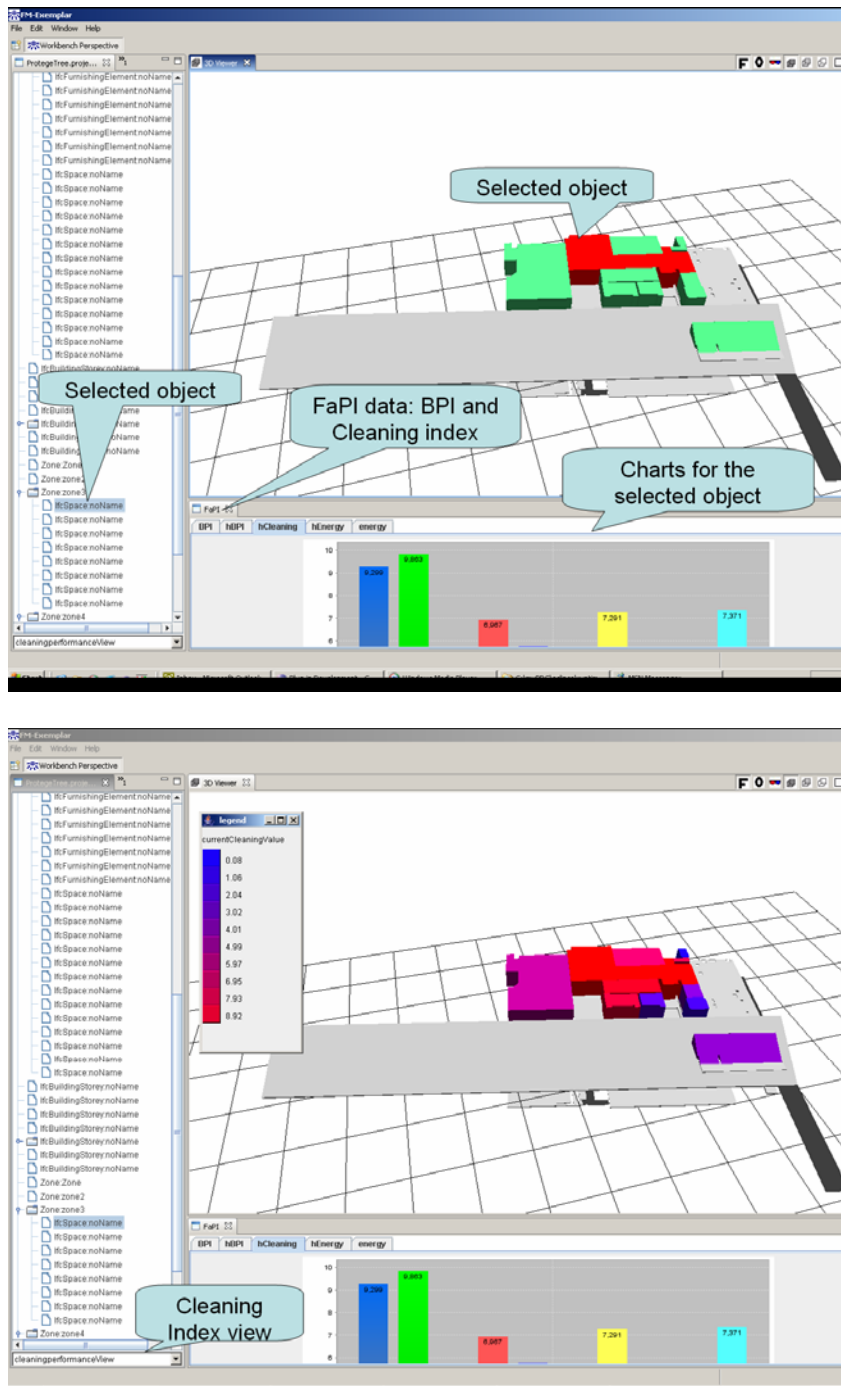

FIG. 12: Screenshots of the ontology based prototype. SOH spaces in a certain Zone can be visualised by browsing through the SOH specific model using the IFC geometry information.

Because the integration ontology has defined that Asset objects are subtypes of benchmark objects, all asset objects are taken into account when executing this query and therefore taking advantage of subsumption relationships.

5. SUMMARY AND CONCLUSIONS

The IFC model enables interoperability between CAD software. Therefore it was possible to convert a structural model developed in Bentley software to an IFC model. This IFC model has been imported in ArchiCad for further development. Re-using the structural model is obviously a major cost saving aspect and the IFC standard enables SOH to gradually build up a digital building model of their facility without being locked in with one software vendor or consultant.

Building objects in the IFC model (such as walls, spaces, doors, etc) have been labelled with a unique ID compliant with SOH's coding system. This coding system greatly supports software integration because several databases containing FM information use the same coding system. Therefore these datasets can be linked to the IFC model using the unique IDs. Semantic Web technology has been used to connect the IFC model and existing databases. IFC objects were linked to OWL objects offering flexibility and opportunities to develop a service oriented software architecture based on W3C standards.

In a prototype semantic objects of the IFC model are converted to OWL leaving all the shape related information in the IFC file. This reduced the size of the OWL file significantly. OWL ontologies containing FM data were linked to the IFC-OWL ontology in order to construct an integrated data model of the SOH facility. Rules are used to give this model the necessary behaviour such as aggregating benchmarks scores. The IFC-OWL coupling enables visualisation of the geometry of the SOH and enabled the interaction with the integrated network of OWL ontologies. Therefore a balance between standardized building information model and more proprietary/specific datasets has been found using standardized W3C technology supporting flexibility and extendibility for future requirements.

6. ACKNOWLEDGEMENT

This research was supported by the Cooperative Research Centre for Construction Innovation (<http://www.construction-innovation.info>). Permission to use the Sydney Opera House data was given by the Sydney Opera House Trust. Arup Australasia, Sydney Office and Woods Bagot contributed to the building model of the Sydney Opera House.

7. REFERENCES

Archibus, www.archibus.com, accessed April 2006.

Ballesty S., Morris J., Ding L., Drogemuller R., Mitchell J., Schevers H., Leifer D., Schwede D., Wu J., Henriksen J., Akhurst A. and Spink G. (2006). An Integrated Collaborative Approach for FM – Sydney Opera House FM Exemplar, Clients Driving Innovation: Moving Ideas into Practice, Gold Coast, Australia.

Berners-Lee T., Hendler J., and Lassila O. (2001). The semantic web, Scientific American <http://www.sciam.com>, Issue May 2001, accessed July 2007.

Cooperative Research Centre for Construction Innovation (CRC-CI), <http://www.construction-innovation.info> accessed July 2007.

CRC-CI Cost Estimator, http://www.construction-innovation.info/images/pdfs/Brochures/Estimator_final.pdf accessed July 2007.

D2RQ, <http://sites.wiwiss.fu-berlin.de/suhl/bizer/pub/Bizer-D2RQ-ISWC2004.pdf>, accessed July 2007.

Daconta M.C., Obrst L.J., and Smith K.T. (2003). The semantic web: A guide to the future of XML, Web Services, and Knowledge Management, Wiley Publishing Inc., Indianapolis, Indiana.

Ding L., Drogemuller R., Rosenman M., Marchant D., and Gero J. (2006). Automating Code Checking for Building Designs - DesignCheck. Clients Driving Innovation: Moving Ideas into Practice. 2nd International Conference of the CRC for Construction Innovation, Gold Coast, Australia.

Drogemuller R.M. (2004). An ICT Platform for AEC, Proc. INCITE 2004, Bejaya Beach Resort, Malaysia.

- Facilities Management Action Agenda (2005) Managing the built environment, Commonwealth of Australia, Australian Government, Department of Industry, Tourism and Resources, Canberra.
- Fensel D. (2002). The semantic web: Yet another hip?, Vrije Universiteit Amsterdam, The Netherlands.
- FIS - Facility Information Systems, www.fisinc.com, accessed April 2006.
- FM:Systems www.fmsystems.com, accessed February 2006.
- Gruber T. What-is-an-ontology? (2003). <http://www-ksl.stanford.edu/kst/what-is-an-ontology.html>, accessed April 2003.
- IAI, International Alliance for Interoperability, <http://www.iai-international.org/>, accessed April 2006.
- Mizoguchi R. (2001). Ontological Engineering Foundation of Next Generation, pp. 44-57, in Zhong, N. et al. (eds.), Web Intelligence: Research and Development, proceedings of the first Asia-Pacific conference (WI 2001), October, Maebashi City, Japan.
- Protégé (2005). Stanford Medical Informatics, <http://protege.stanford.edu>, accessed July 2007.
- Rambyg <http://www.rambyg.dk/>, accessed April 2006.
- RDFGateway, <http://www.intellidimension.com/default.jsp?topic=/pages/site/products/rdfgateway.jsp>, accessed July 2007.
- Rischmoller L., Fisher M., Fox R. and Alarcon L. (2000). 4D Planning and Scheduling (4D-PS): Grounding Construction IT Research in Industry Practice. Proceedings of CIB W78 Conference on Construction Information Technology 2000: Taking the construction industry into the 21st century. June, Iceland.
- Ryhti http://www.granlund.fi/granlund_eng/frameset_tiedonhallinta.htm, accessed April 2006.
- Schevers H. (2004). Demand support by virtual experts. Supporting the client during the inception phase of a building and construction project. PhD thesis 2004. ISBN 90-9019215-2, Schijndel, the Netherlands, also available at <http://www.hansschevers.nl/DemandSupportbyVirtualExperts.pdf>
- Schevers H., Drogemuller R. (2005). Converting IFC Data to the Web Ontology Language, International Conference on Semantics, Knowledge and Grid, Beijing, China.
- Smith M.K., Welty C. and McGuinness D. (2004). OWL web ontology language guide, <http://www.w3.org/TR/owl-guide/>, accessed July 2007.
- SPARQL, <http://www.w3.org/TR/rdf-sparql-query/>, accessed July 2007.
- Sydney Opera House. (2005). Sydney Opera House Building Presentation index (BPI) and Building Fabric Index (BFI) - Functional Specification for Software Development, Sydney Opera House Trust.
- Trinidad G.S., Boulaire F., McNamara C., and Drogemuller R. (2004). Logic programming in a construction planning workbench. Hampson, K. 2004. Brisbane, Australia, CRC for Construction Innovation. 24-10.
- Vizelia, <http://www.vizelia.com>, accessed April 2006.
- Web Ontology Language. (2004). <http://www.w3.org/2004/OWL/>, accessed July 2007.